

OPERATION MANUAL



StreetPro SERIES MODEL SP1E16A PROFESSIONAL PAVEMENT SAW (5HP ELECTRIC MOTOR)

Revision #0 (04/14/10)

To find the latest revision of this
publication, visit our website at:
www.multiquip.com



THIS MANUAL MUST ACCOMPANY THE EQUIPMENT AT ALL TIMES.

PN: 38257

WARNING

CALIFORNIA — Proposition 65 Warning

Engine exhaust and some of its constituents, and some dust created by power sanding, sawing, grinding, drilling and other construction activities contains chemicals known to the State of California to cause cancer, birth defects and other reproductive harm. Some examples of these chemicals are:

- Lead from lead-based paints.
- Crystalline silica from bricks.
- Cement and other masonry products.
- Arsenic and chromium from chemically treated lumber.

Your risk from these exposures varies, depending on how often you do this type of work. To reduce your exposure to these chemicals: **ALWAYS** work in a well ventilated area, and work with approved safety equipment, such as dust masks that are specially designed to filter out microscopic particles.

SILICOSIS/RESPIRATORY WARNINGS

⚠ WARNING



SILICOSIS WARNING

Grinding/cutting/drilling of masonry, concrete, metal and other materials with silica in their composition may give off dust or mists containing crystalline silica. Silica is a basic component of sand, quartz, brick clay, granite and numerous other minerals and rocks. Repeated and/or substantial inhalation of airborne crystalline silica can cause serious or fatal respiratory diseases, including silicosis. In addition, California and some other authorities have listed respirable crystalline silica as a substance known to cause cancer. When cutting such materials, always follow the respiratory precautions mentioned above.

⚠ WARNING

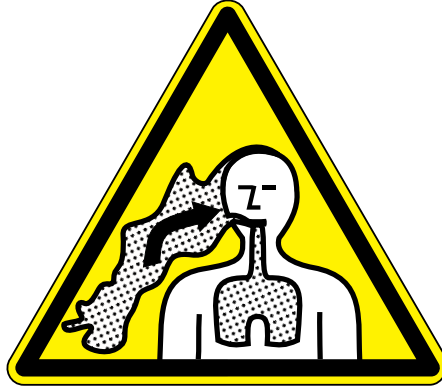

RESPIRATORY HAZARDS

Grinding/cutting/drilling of masonry, concrete, metal and other materials can generate dust, mists and fumes containing chemicals known to cause serious or fatal injury or illness, such as respiratory disease, cancer, birth defects or other reproductive harm. If you are unfamiliar with the risks associated with the particular process and/or material being cut or the composition of the tool being used, review the material safety data sheet and/or consult your employer, the material manufacturer/supplier, governmental agencies such as OSHA and NIOSH and other sources on hazardous materials. California and some other authorities, for instance, have published lists of substances known to cause cancer, reproductive toxicity, or other harmful effects.

Control dust, mist and fumes at the source where possible. In this regard use good work practices and follow the recommendations of the manufacturers or suppliers, OSHA/NIOSH, and occupational and trade associations. Water should be used for dust suppression when wet cutting is feasible. When the hazards from inhalation of dust, mists and fumes cannot be eliminated, the operator and any bystanders should always wear a respirator approved by NIOSH/MSHA for the materials being used.

TABLE OF CONTENTS

SP1E16A Pavement Saw

| | | | |
|--------------------------------------|------|---------------------------------------|-------|
| Proposition 65 Warning | 2 | Controls And Components | 15 |
| Silicosis/Respiratory Warnings | 3 | Inspection/Setup..... | 16-17 |
| Table Of Contents | 4 | Blades..... | 18-20 |
| Training Checklist..... | 6 | Initial Startup | 20 |
| Daily Pre-Operation Checklist | 7 | Operation..... | 21 |
| Safety Information | 8-12 | Maintenance | 21-22 |
| Specifications/Dimensions..... | 13 | Troubleshooting (Electric Motor)..... | 22 |
| General Information..... | 14 | Troubleshooting (Saw) | 23 |

NOTICE

Specifications are subject to change without notice.

TRAINING CHECKLIST

| Training Checklist | | | |
|--------------------|--|-----|------|
| No, | Description | OK? | Date |
| 1 | Read operation manual completely. | | |
| 2 | Machine layout, location of components. | | |
| 3 | Operation of controls (machine not running). | | |
| 4 | Safety controls. | | |
| 5 | Emergency stop procedures. | | |
| 6 | Startup of machine. | | |
| 7 | Starting a cut. | | |
| 8 | Pavement cutting techniques. | | |
| 9 | Stopping a cut. | | |
| 10 | Restart after stopping blade within work surface — explanation | | |
| 11 | Shutdown of machine. | | |
| 12 | Lifting of machine. | | |
| 13 | Machine transport and storage. | | |

DAILY PRE-OPERATION CHECKLIST

| Daily Pre-Operation Checklist | | ✓ | ✓ | ✓ | ✓ | ✓ | ✓ |
|-------------------------------|---------------------------|---|---|---|---|---|---|
| 1 | Hardware and damage check | | | | | | |
| 2 | Condition of blade | | | | | | |
| 3 | ON/OFF switch | | | | | | |
| 4 | Condition of power cable | | | | | | |

SAFETY INFORMATION

Do not operate or service the equipment before reading the entire manual. Safety precautions should be followed at all times when operating this equipment. Failure to read and understand the safety messages and operating instructions could result in injury to yourself and others.



SAFETY MESSAGES

The four safety messages shown below will inform you about potential hazards that could injure you or others. The safety messages specifically address the level of exposure to the operator and are preceded by one of four words: **DANGER**, **WARNING**, **CAUTION** or **NOTICE**.

SAFETY SYMBOLS

! **DANGER**

Indicates a hazardous situation which, if not avoided, **WILL** result in **DEATH** or **SERIOUS INJURY**.

! **WARNING**

Indicates a hazardous situation which, if not avoided, **COULD** result in **DEATH** or **SERIOUS INJURY**.



! **CAUTION**

Indicates a hazardous situation which, if not avoided, **COULD** result in **MINOR** or **MODERATE INJURY**.

NOTICE

Addresses practices not related to personal injury.

Potential hazards associated with the operation of this equipment will be referenced with hazard symbols which may appear throughout this manual in conjunction with safety messages.

| Symbol | Safety Hazard |
|---|------------------------------|
|  | Rotating parts hazards |
|  | Cutting and crushing hazards |
|  | Electric shock hazards |

SAFETY INFORMATION

GENERAL SAFETY

CAUTION

- **NEVER** operate this equipment without proper protective clothing, shatterproof glasses, respiratory protection, hearing protection, steel-toed boots and other protective devices required by the job or city and state regulations.



- Avoid wearing jewelry or loose fitting clothes that may snag on the controls or moving parts as this can cause serious injury.

- **NEVER** operate this equipment when not feeling well due to fatigue, illness or when under medication.



- **NEVER** operate this equipment under the influence of drugs or alcohol.



- **ALWAYS** clear the work area of any debris, tools, etc. that would constitute a hazard while the equipment is in operation.

- No one other than the operator is to be in the working area when the equipment is in operation.

- **DO NOT** use the equipment for any purpose other than its intended purposes or applications.

NOTICE

- This equipment should only be operated by trained and qualified personnel 18 years of age and older.

- Whenever necessary, replace nameplate, operation and safety decals when they become difficult read.

- Manufacturer does not assume responsibility for any accident due to equipment modifications. Unauthorized equipment modification will void all warranties.

- **NEVER** use accessories or attachments that are not recommended by Multiquip for this equipment. Damage to the equipment and/or injury to user may result.

- **ALWAYS** know the location of the nearest fire extinguisher.



- **ALWAYS** know the location of the nearest first aid kit.



- **ALWAYS** know the location of the nearest phone or **keep a phone on the job site**. Also, know the phone numbers of the nearest **ambulance, doctor and fire department**. This information will be invaluable in the case of an emergency.



SAFETY INFORMATION

SAW SAFETY

DANGER.

- **NEVER** operate the equipment in an explosive atmosphere or near combustible materials. An explosion or fire could result causing severe **bodily harm or even death.**



WARNING

- Accidental starting can cause severe injury or death. **ALWAYS** place the ON/OFF switch in the OFF position.



- **NEVER** disconnect any **emergency or safety devices.** These devices are intended for operator safety. Disconnection of these devices can cause severe injury, bodily harm or even death. Disconnection of any of these devices will void all warranties.

CAUTION

- Anytime the saw is lifted onto its nose or tilted fully back, such as for maintenance access, the high end of the saw **MUST** be blocked up to prevent the possibility of crush injury.

NOTICE

- **ALWAYS** ensure saw is **securely** placed on appropriate blocks or jackstands when performing maintenance requires elevation of the saw.
- If saw has brakes, ensure brakes are applied when leaving or when using on a slope. Some saws utilize a brake system where the brakes are automatically applied when the motor is stopped.
- If saw has a parking brake, ensure that the parking brake is engaged and holds the saw safely in place when parking on a slope. Turning the saw across the angle of the slope will help prevent accidental downhill movement.
- **ALWAYS** block the saw with appropriate blocks when leaving the saw parked on a slope.
- To prevent unexpected loss of control, **DO NOT** start saw on a sloping surface
- **DO NOT** use on excessive slopes or on extremely uneven surfaces
- **ALWAYS** keep the machine in proper running condition.
- Fix damage to machine and replace any broken parts immediately.
- Make sure there is no buildup of concrete, grease, oil or debris on the machine.
- **ALWAYS** store equipment properly when it is not being used. Equipment should be stored in a clean, dry location out of the reach of children and unauthorized personnel.

SAFETY INFORMATION

BLADE SAFETY

⚠ WARNING

- Rotating blade can cut and crush. **ALWAYS** keep hands and feet clear while operating the saw.



⚠ CAUTION

- **NEVER** operate the saw without blade guards and covers in place. Exposure of the diamond blade must not exceed 180 degrees.
- **ALWAYS** ensure that unit is unplugged (disconnected) when installing blade.
- Verify the electric motor is set to the OFF position before installing a blade.
- **ALWAYS** inspect blade before each use. The blade should exhibit no cracks, dings, or flaws in the steel centered core and/or rim. Center (arbor) hole must be undamaged and true.



NOTICE

- Use proper blades and follow blade manufacturer's recommendations. Match the blade RPM (blade shaft RPM) to the recommended blade surface feet per minute (SFPM).
- Ensure the 5/8" blade-mounting bolt is tightened to 125-175 foot lbs. of torque.
- **ALWAYS** examine blade flanges for damage and excessive wear.
- Ensure the blade is marked with an operating speed greater than the spindle speed of the saw.
- Only cut the material that is specified for the diamond blade. Read the specification of the diamond blade to ensure the proper tool has been matched to the material being cut.
- If wet cutting, ensure a **WET CUTTING** blade is being used and that the water supply system to the blade is properly functioning and being used.
- **DO NOT** drop the diamond blade on ground or surface.
- Ensure that the blade is mounted for proper operating direction.
- Adhere to the blade manufacturer's recommendations on handling, storage and safe usage of blades.

ELECTRIC MOTOR SAFETY

NOTICE

- Operate electric motor only at the specified voltage indicated on the nameplate.
- **DO NOT** spray water onto electric motor.
- **ALWAYS** disconnect AC power plug from power source before moving saw.
- **ALWAYS** make sure the ON/OFF switch on the electric motor is in the OFF position when not in use and before inserting the mixer's power plug into an AC receptacle.



POWER CORD/CABLE SAFETY

⚠ DANGER

- **NEVER** let power cords or cables lay in water.
- **NEVER stand in water** while AC power from the generator is being transferred to a load.
- **NEVER** use **damaged** or **worn** cables or cords when connecting equipment to power source. Inspect for cuts in the insulation.
- **NEVER** grab or touch a live power cord or cable with wet hands. The possibility exists of **electrical shock, electrocution or death.**



⚠ CAUTION

- Ensure that cables and cords will not be tripped over or trapped underneath the saw.

NOTICE

- **ALWAYS** make certain that proper power or extension cord has been selected for the job. See Cable Selection Chart in this manual.

SAFETY INFORMATION

LIFTING SAFETY

CAUTION

- **NEVER** allow any person or animal to stand underneath the equipment while lifting.
- **DO NOT** attempt to lift the saw by the guards, handle bars or front pointers.

NOTICE

- When lifting of the saw is required, use a forklift.
- **DO NOT** lift machine to unnecessary heights.
- **NEVER** lift the equipment while the motor is running.
- **ALWAYS** use ramps capable of supporting the weight of the saw and the operator to load and unload the saw.

TRANSPORTING SAFETY

NOTICE

- **ALWAYS** shutdown saw before transporting.
- **ALWAYS** tie down equipment during transport by securing the equipment with rope.
- Ensure that the diamond blade does not come into contact with the ground or surface during transportation.
- **NEVER** transport the saw to or from the job site with the blade mounted.

ENVIRONMENTAL SAFETY

NOTICE

- Dispose of hazardous waste properly. Examples of potentially hazardous waste are used motor oil, fuel and fuel filters. 
- **DO NOT** use food or plastic containers to dispose of hazardous waste.
- **DO NOT** pour waste, oil or fuel directly onto the ground, down a drain or into any water source.

DECOMMISSIONING

Metal Parts Recycling

NOTICE

- When the life-cycle of this equipment is over, it is recommended that the steel frame and all other metal parts be sent to a recycling center. 
- Metal recycling involves the collection of metal from discarded products and its transformation into raw materials to use in manufacturing a new product.
- Recyclers and manufactures alike promote the process of recycling metal. Using a metal recycling center promotes an energy cost savings.

Rubber Parts Recycling

NOTICE

- Contact your country's Department of Public Works or recycling agency in your area and arrange for proper disposal of any rubber components associated with this equipment. 

SPECIFICATIONS/DIMENSIONS

| Table 1. Electric Motor Specifications | |
|--|---|
| Electric Motor | 5HP, Single Phase 230 VAC Electric Motor |
| Max Output | 5 HP/3450 RPM |
| Starting Method | Electric |
| Input Voltage | 230 VAC |
| Max Amps | 19.5 |
| Approx. Weight | 72 lbs. (32.7 kg) |
| Phase | Single |
| Frequency | 60 Hz |
| Power Factor | 99 |
| Approx. Dimensions (L x W x H) | 17.25 x 8.63 x 9 in. (438 x 219 x 229mm) |

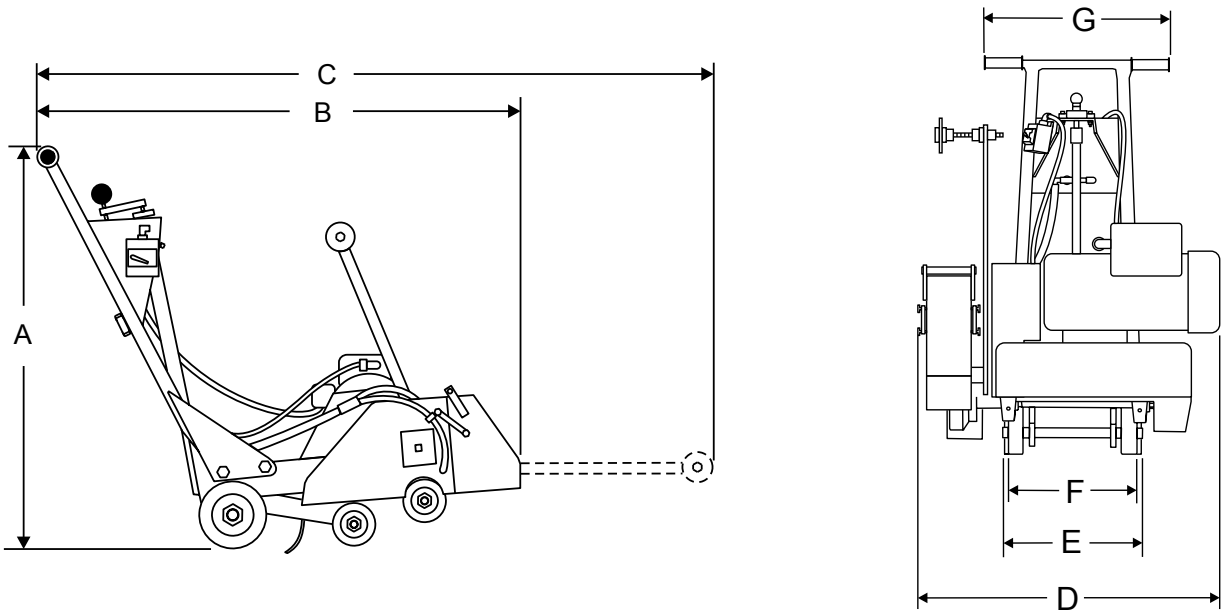

Figure 1. SP1E16A Dimensions

| Table 2. SP1E16A Dimensions | | |
|-----------------------------|------------------------------------|--------------------|
| Reference Letter | Description | Dimension (cm) |
| A | Max Height | 37.0 In. (94 cm) |
| B | Max Length (Front Pointer Raised) | 32.0 In. (80 cm) |
| C | Max Length (Front Pointer Lowered) | 54.5 In. (138 cm) |
| D | Max Width | 21.5 In. (55 cm) |
| E | Rear Wheel Base | 17.0 In. (40 cm) |
| F | Front Wheel Base | 10.0 In. (25.4 cm) |
| G | Handle Bar Width | 21.5 In. (55 cm) |

GENERAL INFORMATION

The Multiquip SP1E16A walk-behind saw is designed for wet or dry cutting of concrete or asphalt utilizing diamond blades. These saws have been engineered for general and industrial flat sawing applications. The reinforced steel box frame design adds strength necessary to reduce vibrations while cutting. Minimizing vibrations enhances the performance of the blade and extends the life of the saw.

Heavy-duty front and rear axles, sturdy oversized wheels, and industrial under carriage assembly ensure accurate tracking and years of reliable use.

Additionally, the general weight-to-strength ratio design of the frame and chassis assembly provides for optimum weight distribution to keep the blade running true in the cut. A rugged blade shaft bearing assembly ensures minimal flutter and shaft harmonics providing the most advantageous condition for a diamond blade at operating speeds.

The SP1E16A saw comes standard with a 16-inch blade guard and can handle diamond blades ranging in size from 12-16-inch in diameter.

The blade shaft accommodates a 1" arbor.

An ACME thread, manual raise/lower assembly, easily raises and lowers the blade and locks it into position to ensure a constant depth cut. The SP1E16A is equipped with a retractable cutting guide, oversized roller bearing wheels, industrial blade shaft bearings, and a rigid steel frame.

POWER PLANTS

The SP1E16A saw is generally classified in the industry as a "LOW to MEDIUM " horsepower saw. This classification is particularly useful when selecting the proper diamond blade for an application.

Refer to the electric motor Owner's Manual for specific instructions regarding motor operation and maintenance practices.

The SP1E16A saw is powered by a 5.0 HP, 230 VAC single-

phase electric motor. Blade rotation is belt driven.

All Multiquip SP1E16A saws are designed, engineered and manufactured with strict adherence to American National Standards Institute, Inc. (ANSI) guidelines B7.1 and B7.5.

WATER SYSTEM

The SP1E16A saw provides a hardy water plumbing system that evenly distributes optimum water volume and flow rate to both sides of the blade to keep the blade cool when cutting. The basic water system consists of a standard "garden hose" valve that connects the water source (via a hose) to the saw.

FEATURES

- Super-rigid box frame- ensures straight cuts while resisting warping and vibration.
- Rugged roller bearing wheels for long service life.
- Comfortable grip handles
- Easy cranking for manually raising/lowering the blade to the desired cutting height.
- Hinged front, lift-up blade guard is designed to provide easy blade replacement.
- Saw position guide helps ensure straight cuts.
- Water system provides optimum flow and volume of water to both sides of the blade.

CONTROLS AND COMPONENTS

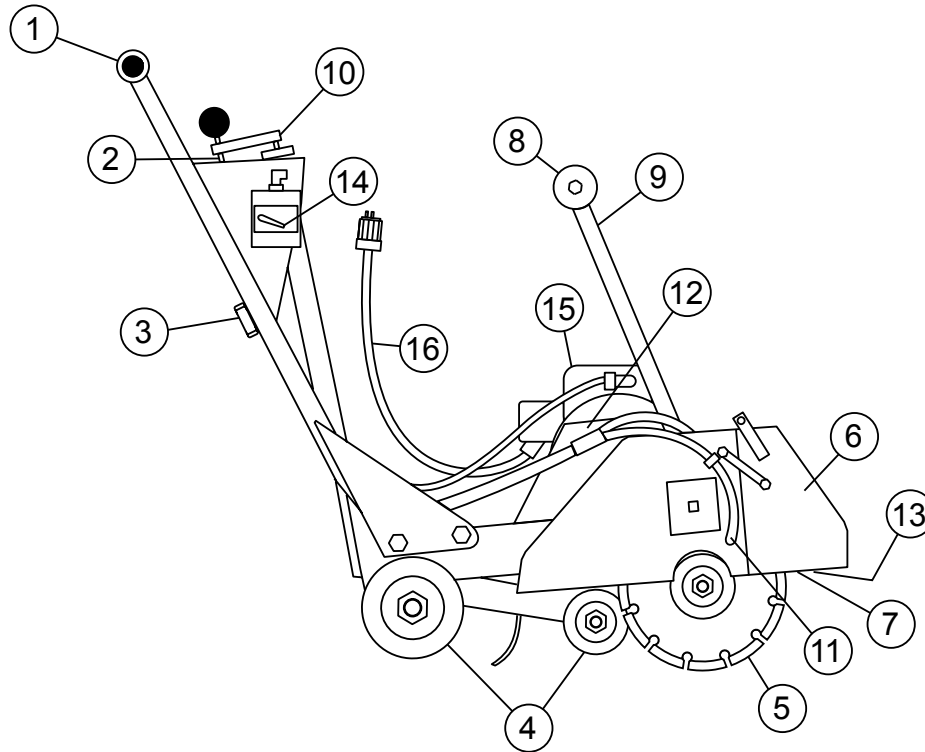

Figure 2. SP1E16A Controls and Components

Figure 2 shows the location of the basic controls and components for the SP1E16A. Listed below is a brief explanation of each control or component.

1. **Hand Grips/Handlebar** — When operating the saw, place both hands on each grip to maneuver the saw. Replace hand grips when they become worn or damaged.
2. **Handle Lock** — Lock blade depth to desired position.
3. **Garden Hose Connector** — Connect to water source to provide blade cooling while cutting concrete or asphalt.
4. **Wheels/Carriage Assembly** — Heavy-duty polyurethane wheels with permanently sealed ball bearings.
5. **Cutting Blade** — Use appropriate type blades for cutting concrete or asphalt. Requires 1" arbor.
6. **Blade Guard** — Covers saw blade and flips up to allow blade to be changed.
7. **Belt Tension Adjuster** — Adjusts belt tension.
8. **Front Pointer** — Front pointer wheel assists in straight tracking.
9. **Front Pointer Arm** — Stows up for storage and pivots down for use.
10. **Cutting Depth Adjuster** — turn operating crank clockwise or counter-clockwise to adjust the cutting depth up or down.
11. **Blade Coolant System** — Provides cooling water to blade during cutting operations.
12. **V-Belt Cover** — Remove this cover to gain access to the V-belt. NEVER operate the saw with this cover removed.
13. **Arbor Shaft Grease Zerks** — Conveniently located for lubrication.
14. **On/Off Switch** — Turn to the "ON" position to allow motor to be started and turn to the "OFF" position to shut the motor off.
15. **Electric Motor** — 230 VAC, 60 Hz, single phase @ 19.5 Amps
16. **Power Cable** — Connect to a 230 VAC, power source @ 19.5 Amps.

INSPECTION/SETUP

1. Read and fully understand this manual, the safety instructions in particular, and the motor manufacturer's manual supplied with the saw.



2. Select the correct blade for each application. If abrasive blades are used, **MAKE CERTAIN** they are designed for use on a concrete floor saw. They must be reinforced and have a hole for the driving pin. When wet cutting with an abrasive blade, **MAKE CERTAIN** the blade is intended for wet cutting. Water will destroy a dry cut abrasive blade. Some diamond blades require water cooling and failure to do so will destroy them almost immediately. Other diamond blades can be used with or without water. Refer to the Blades and Blade Placement sections in this manual for further information.

3. Handle all blades with care and **NEVER** use a damaged blade. **NEVER** use an abrasive blade that has been dropped.

Electric Motor

1. The motor should be connected to a power source in compliance with all local electrical codes. This must be performed by a qualified electrician. After this connection is made, it will be necessary to check the rotation of the motor shaft. The shaft rotation **MUST** be counter-clockwise when viewing the motor from the shaft extension end. If the rotation of the shaft is incorrect make the necessary changes for the correct shaft rotation.

2. **MAKE CERTAIN** the rated line voltage is at the motor when cutting. Motors can burn out when the voltage falls 10% below the voltage rating of the motor. Also use the correct heavy duty circuit breakers or fuses in the circuit.

3. **MAKE CERTAIN** the correct size extension cord is used. Undersize wires will burn out motors. Use the following chart to determine the extension cord size.

| Table 3. Extension Cord Sizes | | | | |
|-------------------------------|---------|----------|----------|-----------|
| Motor | Voltage | 50' Long | 75' Long | 100' Long |
| 5hp single phase | 230 | No. 10 | No. 8 | No. 6 |

WARNING



ALWAYS use a grounded extension cord and make certain the motor is connected to a properly grounded electrical circuit to protect the operator from possible electric shock.

DANGER

ALWAYS use a grounded (3-wire) extension cord and **MAKE CERTAIN** that the motor is connected to a properly grounded electric circuit to protect the operator from possible electric shock.

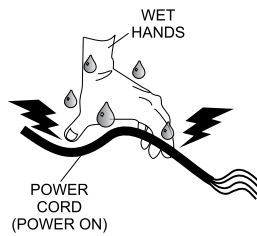

NEVER touch the power cord with wet hands or while standing in water when it is connected to a power source. The possibly exists of electrical shock (electrocution) or even death. **NEVER** spray water directly on the electric motor.

Guards And Covers

WARNING

NEVER operate the saw without blade guards and covers in place. **DO NOT** operate with the front of the blade guard raised. The blade exposure cannot exceed 180 degrees during operation. Adhere to the safety guidelines of the **American National Standards Institute (ANSI) B7.1 and B7.5**.



Figure 3. Blade Guard

INSPECTION/SETUP

Check the following on the blade guard (Figure 3):

- Ensure the capacity of the blade guard matches the diameter of your diamond blade.
- Check that the guard is bolted firmly upon the saw frame.
- Check that the spring tensioned front cover of the guard is firmly seated with the rear section of the guard and there are no gaps. **NEVER** lift the blade guard while cutting.

Ensure the v-belt cover is in place and securely fastened during operation of the saw (Figure 4).

V-Belt Check

A worn or damaged V-belt can adversely affect the performance of the saw. If a V-belt is defective or worn, replace **ALL** the V-belts. V-belts should always be replaced in sets.

CAUTION



NEVER attempt to check the V-belt with the engine running. Severe injury can occur. Keep fingers, hands, hair, and clothing away from all moving parts.

V-belt Alignment and Tensioning

This saw is equipped with a premium V-belt that has been aligned and tensioned by factory personnel. The V-belt must be aligned and tensioned for proper operation of the saw.

Use the following procedure to check the alignment of V-belt:

1. Remove the bolts that secure the V-belt cover (Figure 4) to the saw frame.



Figure 4. V-Belt Cover

2. Check uniform parallelism (Figure 5) of V-belt and pulley (sheaves). Use a straight-edge or machinist's square against both pulleys and adjust both pulleys until equally aligned.

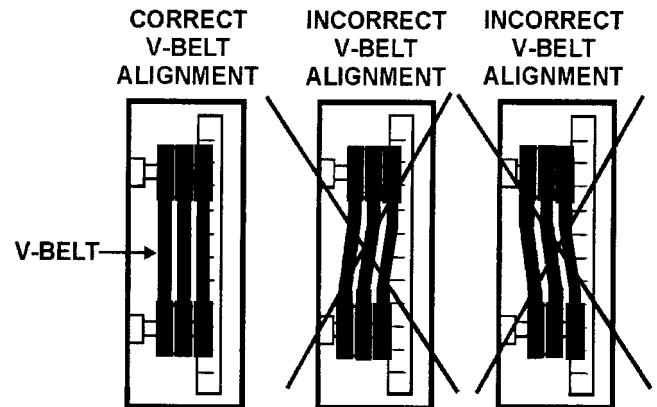

Figure 5. Pulley Alignment

3. Check V-belt tension by using a tension meter (3.0 lbs.) against the inside belt at a mid point between the two pulleys, or by deflecting the center belt at a mid point $3/16$ " (5 mm).
4. **DO NOT** over or under tighten the V-belt. Severe damage can occur to the saw and engine crankshaft if the belt is over-tensioned. A decrease of power to the blade and poor performance will result if the belt is under-tensioned (loose on pulleys).

NOTICE

V-belt alignment must be rechecked after adjusting belt tension.

Saw blades, or cutting disks, are available in either an abrasive design or as diamond blades. Either blade will work on the SP1E16A, however, diamond blades are recommended. Ask your dealer about your specific cutting application.

WARNING



Failure to thoroughly inspect the diamond blade for operational safety could result in damage to the blades or the saw and may cause injury to the user or others in the operating area.

Figure 6 highlights the components of a diamond blade.

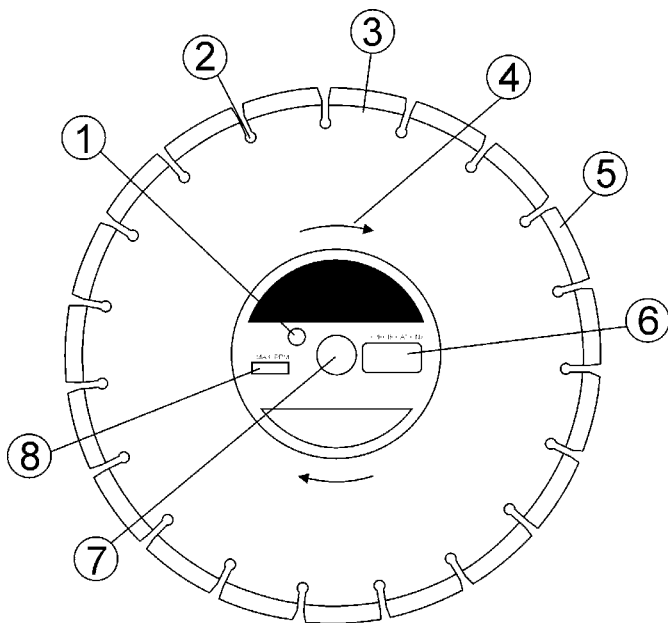

Figure 6. Diamond Blade

1. **Drive Pin Hole** — A commonly located hole on the diamond blade core that prevents operational blade slippage between the inner & outer blade flanges (collars). Inspect the diameter of the hole to ensure there is no distortion, and that a snug fit develops between the hole and drive pin.
2. **Stress Relief Holes (Gullets)** — Check the steel core for cracks that may have propagated from the slots and/or gullets. Cracks indicate extreme fatigue failure and if sawing continues, catastrophic failure will occur.

3. **Edge Of The Steel Core** — Check the diameter edge for discoloration (blue oxidation) indicating an overheating condition caused by insufficient cooling water/air. Overheating of blades may lead to loss of core tension and/or increase the possibility for blade failure. Check to make sure the steel core's width is uniform about the rim of the blade, and not succumbing to an "under cutting" condition brought about by highly abrasive material or improper under cutting core protection.
4. **Directional Arrow** — Check to ensure that the blade is oriented properly on the spindle for sawing. Reference the directional arrow on the blade and place it so the direction of rotation "downcuts" with the turn of the shaft.
5. **Diamond Segment or Rim** — Ensure there are no cracks, dings, or missing portions of the diamond segment/rim. **DO NOT use a blade that is missing a segment or a portion of the rim.** Damaged and/or missing segments/rims may cause damage to your saw, and injury to the user or others in the operating area.
6. **Specifications** — Ensure that the blade specifications, size, and diameter properly match up to the sawing operation. Wet blades must have water to act as a coolant. Utilizing a diamond blade not matched properly to the task may result in poor performance and/or blade damage.
7. **Arbor Hole** — It is essential that the arbor hole diameter properly matches the shaft arbor (1"), and that it is free from distortions. Correct blade flanges (collars) must be used. The inside face of the flanges must be clean & free of debris. An out of round arbor condition will cause damage to the blade and the saw.
8. **MAX RPM** — This RPM reference is the maximum safe operating speed for the blade selected. **NEVER** exceed the max RPM on the diamond blade. Exceeding the MAX RPM is dangerous, and may cause poor performance and may damage the blade. All blades used must be designed for the maximum spindle RPM.

BLADE PLACEMENT

1. **Blade Guard** — Pivot the blade guard front cover all the way back. The guard tension spring will keep the front cover in position.
2. **Blade Hex Nut** — Unscrew the blade shaft nut (right side loosens clockwise and tightens counter-clockwise while the left side loosens counter-clockwise and tightens clockwise. **DO NOT** overtighten the nut (approximately 45-50 ft. lb/61-68 N/m) when finalizing the assembly.
3. **Outside Blade Flange (Collar)** — Ensure that the outside blade flange is placed flush against the diamond blade. The inside surface of the flange must be free of debris and permit a tight closure on the surface of the blade core.
4. **Diamond Blade** — Ensure that the proper diamond blade has been selected for the job. Pay close attention to the directional arrows on the blade. The blade's operating directional arrows must point in a "down-cutting" direction to perform correctly. When placing the blade onto the blade shaft, ensure the arbor hole of the blade matches the diameter of the shaft.
5. **Inner Flange (Collar)** — This flange is fixed upon the blade shaft. The inside surface of the flange must be free of debris and permit a tight closure on the surface of the blade.

BLADE SPEED

A diamond blade's performance is directly connected to specific peripheral (rim) speeds.

The following shaft rotational speeds have been factory set to ensure optimum blade performance.

SP1E16A 16-inch (406.4 mm) Capacity – 2,718 RPM

NOTICE

The following steps should be accomplished before using the saw on any cutting surface.



WARNING



Dropping or forcing the blade onto the cutting surface can severely damage the diamond blade and may cause serious damage to the saw and bodily harm.

Blade Removal and Replacement

CAUTION

ALWAYS ensure that unit is unplugged (disconnected) when installing blade.

1. Set the motor ON/OFF switches to the **OFF** position to prevent accidental starting. 
2. Place the saw on a stable level working surface.
3. Ensure the blade is raised and the raise/lower crank is locked into position.

NOTICE

When removing or installing a diamond blade, please note that the blade retaining nuts are left and right-hand threaded.

4. Lift up the blade guard cover to gain access to the blade.

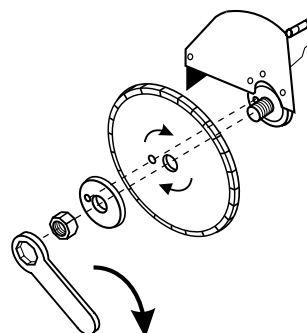

Figure 7. Mounting the Diamond Blade

5. Use the provided blade nut wrench to remove and install the blade (Figure 7).
6. Unscrew the spindle nut (right side loosens clockwise and tightens counter-clockwise while the left side loosens counter-clockwise and tightens clockwise). **DO NOT** overtighten the nut (approximately 45-50 ft. lb/61-68 N/m) when finalizing the assembly.

BLADES/INITIAL STARTUP

Cutting Depth Adjustment

The saw is equipped with a Raise/Lower Assembly that is supported by the following components.

- Raise/Lower Acme Screw
- Jack Arm
- Blade Guard
- Adjusting Handle Crank

INITIAL STARTUP

CAUTION

DO NOT attempt to operate the saw until the Safety, General Information and Inspection sections of this manual have been read and thoroughly understood. See motor manufacturer's operating manual.



NEVER operate the saw in a confined area or enclosed area structure that does not provide ample free flow of air.



ALWAYS wear approved eye and hearing protection before operating the saw.



NEVER place hands or feet inside the belt guard or blade guard while the engine is running. **ALWAYS** shut the engine down before performing any kind of maintenance service on the saw.

1. Ensure the diamond blade has been mounted correctly and that it is raised above the surface you are about to saw.
2. Use an extension cord (see Table 3) of adequate current carrying capacity. Insert the electric motor's power plug into one end of the extension cord.

CAUTION

MAKE CERTAIN that the electric motor's power switch is in the OFF position before plugging the motor into the power source.

DANGER

- NEVER** use a worn or frayed extension cord.
- NEVER** operate saw with V-belt cover removed.

DANGER

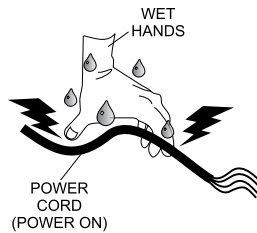

NEVER touch the power cord with wet hands or while standing in water when it is connected to a power source. There possibly exists of electrical shock (electrocution) or even death. **NEVER** spray water directly on the electric motor.

3. Plug the other end of the extension cord into a 230VAC power source. Remember to read the nameplate to determine the motor's input voltage requirement.

WARNING

ALWAYS read the label on the electric motor before applying power. The label will indicate the correct power requirements for the motor. Remember, the use of an incorrect input voltage will severely damage the electric motor.

MAKE CERTAIN the motor is connected to a functional ground fault circuit interrupter.

STARTING THE ELECTRIC MOTOR

1. Before starting, **MAKE CERTAIN** there is enough clearance between the blade and the ground.
2. Set the electric motor's ON/OFF switch (Figure 8) to the ON position.



Figure 8. Electric Motor ON/OFF Switch

3. Before the saw is placed into operation, run the motor for several minutes. Check for noises that would be associated with loose guards and/or covers.

OPERATION/MAINTENANCE

OPERATION

⚠ WARNING



ALWAYS keep clear of **rotating** or **moving** parts while operating this equipment.

NOTICE

MAKE CERTAIN to raise the spindle high enough for the blade to clear the pavement.

⚠ WARNING

MAKE CERTAIN the saw path is clear of debris and obstructions to prevent tripping and/or falling onto the saw, and to prevent debris from hitting the blade.

1. To begin sawing, lower the rotating blade allowing it to cut to the preset depth.
2. When the blade has reached full cutting depth, slowly walk behind the saw at a rate that will allow the motor to operate without losing optimum RPM.

⚠ CAUTION

DO NOT try to cut faster than the blade will allow. Cutting too fast will cause the blade to rise up out of the cut. Improper cutting rate can decrease the life of the motor and blades.

NOTICE

Mark the cutting line clearly. **ONLY saw in a straight line.**

3. When the end of the cut has been reached, raise the blade out of the cut by pulling back on the handlebars (using a downward pressure) until the raise/lower rod drops into its slots with the blade in the raised position.
4. If cutting is complete, turn the motor off and wait for the blade to stop rotating.

STOPPING THE SAW

1. Place the electric motor's ON/OFF switch in the OFF position.
2. Disconnect the electric motor's extension cord from its power source.

MAINTENANCE

⚠ WARNING

ALWAYS ensure that the motor ON/OFF switch is in the **OFF** position, the power cable is unplugged, and that the arbor shaft has **COMPLETELY STOPPED ROTATING** before performing any of the following operations:

- Removing or installing blades
- Adjusting front or rear pointers
- Lubricating any components
- Removing motor mounting bolts
- Inspecting, adjusting, or replacing drive belt, arbor shaft, or arbor shaft bearings

Saw Blade Removal and Installation

See "Blade Removal and Replacement" section in this manual.

Front Pointer Adjustment

⚠ CAUTION

ALWAYS ensure that unit is unplugged (disconnected) when installing blade.

The front pointer wheel has been set at the factory. Use these procedures only if the pointer is suspect of being out of alignment.

1. Chalk out a straight line on the prepared slab or cutting surface.
2. Use a 4 foot straight-edge or level by placing it flat against the blade.
3. Adjust the front pointer wheel so it just touches the side of the straight-edge or level.
4. Remove the straight-edge or level.
5. Position the front pointer and blade directly over the chalk line.
6. Start the saw and lower the blade onto the chalk line.
7. Begin cutting and make sure the blade follows the chalk line as closely as possible.
8. The pointer should follow the chalk line as well. If it does not, adjust the pointer by loosening then tightening the jam nuts on the pointer until the pointer follows the same path as the blade.

MAINTENANCE/TROUBLESHOOTING (ELECTRIC MOTOR)

Chassis Lubrication

■ **Blade Shaft Bearings** — Two zerk fittings are located at the lower-front area of the saw. Lubricate before daily use. Use a good quality automotive or general purpose grease. Check and lubricate more often if unit is under heavy use. Do not overfill bearings. Overfilling can damage the grease seals which can result in bearing exposure to dirt and contaminants which can then shorten the life of the bearings. Excess grease can also drip onto the cutting surface.

V-Belt

See "V-belt Alignment and Tensioning" section in this manual.

TROUBLESHOOTING

| Symptom | Possible Cause | Solution |
|------------------------------------|---|---|
| Electric motor will not start. | Is there power? | Check power source. Check reset button. |
| | Is power cable plugged in? | Plug in power cable. |
| | Is ON/OFF switch placed in ON position? | Place ON/OFF switch in ON position. |
| | Defective cable? | Check cable. |
| Electric motor continuously stops. | Reset button OK? | Check power source. |
| Electric motor RPM's too low. | Low voltage? | Check input voltage (230 VAC). |
| Electric motor RPM's too high. | High voltage? | Check input voltage (230 VAC). |

TROUBLESHOOTING (SAW)

Table 5. Blade Troubleshooting

| Symptom | Possible Problem | Solution |
|--|--|--|
| Blade slows or stops cutting. | Blade too hard for the material being cut? | Consult dealer or Multiquip for correct blade. Try cutting very soft material (sandstone, silica, brick, cinder block) to “redress” the blade. |
| | Engine torque diminished because of loose V-belt? | Tighten and/or replace V-belts. |
| | Insufficient engine power? | Check throttle setting. Check engine horsepower. |
| | Improper direction of rotation? | Check that the blade is properly oriented and rotational arrow points in a down-cutting direction. |
| | Blade is slipping on the bladeshaft? | Check that the blade and flange pins are properly installed on the bladeshaft. |
| Blade does not cut straight and/or true. | Blade being used on misaligned saw? | Check bladeshaft bearings and alignment integrity. |
| | Blade is excessively hard for the material being cut? | Check specification of the blade with the material being cut. Consult dealer or Multiquip for information. |
| | Blade being used at improper RPM? | Ensure blade surface feet per minute speed (SFPM) is approximately 6,000. |
| | Blade improperly mounted on arbor shoulders and flanges? | Ensure blade is properly affixed on the bladeshaft. |
| | Excessive force applied to blade while cutting? | DO NOT force the blade in the cut. Apply a slow and steady pace when sawing. |
| Blade discoloring, crackling and/or wearing excessively. | Blade too hard for the material being cut? | Consult dealer or Multiquip for correct blade. Try cutting very soft material (sandstone, silica, brick, cinder block) to “redress” the blade. |
| | Blade improperly mounted on arbor shoulders and flanges? | Ensure blade is properly affixed on the bladeshaft. |
| | Blade not receiving enough cooling water? | Ensure proper flow and volume of water is provided for wet cutting blades. |
| | Arbor hole out of round? | Ensure blade is properly affixed on the bladeshaft. |
| | Incorrect blade chosen for material being cut? | Check specification of the blade with the material being cut. Consult dealer or Multiquip for information. |
| | Excessive force applied to blade while cutting? | DO NOT force the blade in the cut. Apply a slow and steady pace when sawing. |

OPERATION MANUAL

HERE'S HOW TO GET HELP

PLEASE HAVE THE MODEL AND SERIAL
NUMBER ON-HAND WHEN CALLING

UNITED STATES

Multiquip Corporate Office

18910 Wilmington Ave.
Carson, CA 90746
Contact: mq@multiquip.com

Tel. (800) 421-1244
Fax (800) 537-3927

Mayco Parts

800-306-2926
310-537-3700

Fax: 800-672-7877
Fax: 310-637-3284

Service Department

800-421-1244
310-537-3700

Fax: 310-537-4259

MQ Parts Department

800-427-1244
310-537-3700

Fax: 800-672-7877
Fax: 310-637-3284

Warranty Department

800-421-1244, Ext. 279
310-537-3700, Ext. 279

Fax: 310-537-1173

Technical Assistance

800-478-1244

Fax: 310-631-5032

MEXICO

MQ Cipsa

Carr. Fed. Mexico-Puebla KM 126.5
Momoxpan, Cholula, Puebla 72760 Mexico
Contact: pmastretta@cipsa.com.mx

Tel: (52) 222-225-9900
Fax: (52) 222-285-0420

UNITED KINGDOM

Multiquip (UK) Limited Head Office

Unit 2, Northpoint Industrial Estate,
Global Lane,
Dukinfield, Cheshire SK16 4UJ
Contact: sales@multiquip.co.uk

Tel: 0161 339 2223
Fax: 0161 339 3226

CANADA

Multiquip

4110 Industriel Boul.
Laval, Quebec, Canada H7L 6V3
Contact: jmartin@multiquip.com

Tel: (450) 625-2244
Tel: (877) 963-4411
Fax: (450) 625-8664

© COPYRIGHT 2010, MULTIQUIP INC.

Multiquip Inc and the MQ logo are registered trademarks of Multiquip Inc. and may not be used, reproduced, or altered without written permission. All other trademarks are the property of their respective owners and used with permission.

This manual MUST accompany the equipment at all times. This manual is considered a permanent part of the equipment and should remain with the unit if resold.

The information and specifications included in this publication were in effect at the time of approval for printing. Illustrations, descriptions, references and technical data contained in this manual are for guidance only and may not be considered as binding. Multiquip Inc. reserves the right to discontinue or change specifications, design or the information published in this publication at any time without notice and without incurring any obligations.

Your Local Dealer is:

